

Lamellenvorhang L1/DL1/LS (Slope) Store
à lamelles L1/DL1/LS (inclinaison)

Jalousien.com
Ihr Online-Fachhändler.

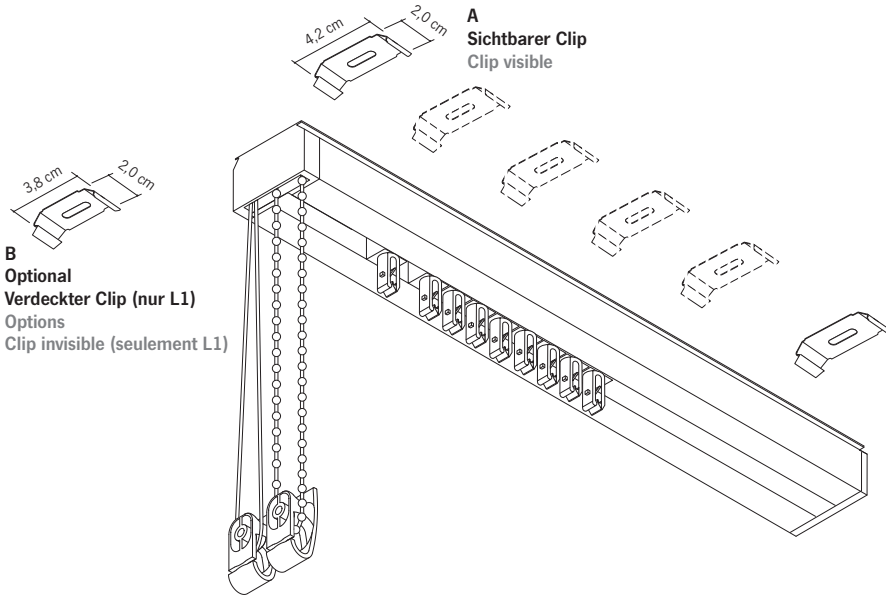

Achtung Attention:

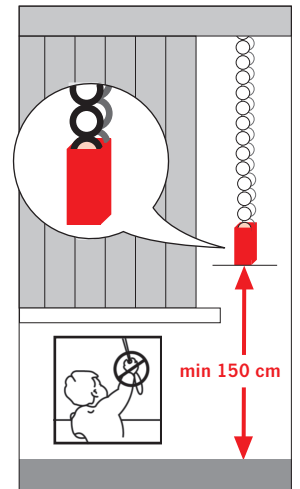

Montagezubehör

Das beiliegende Befestigungsmaterial gilt nur für feste Untergründe. Für die Montage haftet der Montierende.

Accessoires de montage

Le matériel de fixation joint ne peut être appliqué que sur des bases solides. La personne chargée du montage est responsable du montage.

Montagepunkte bestimmen
Déterminer les points de montage

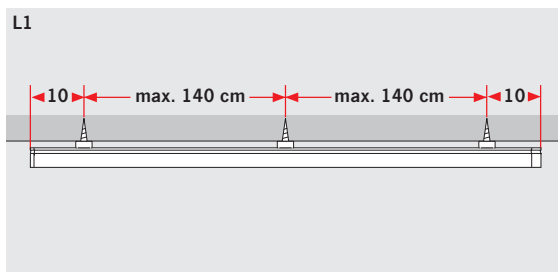
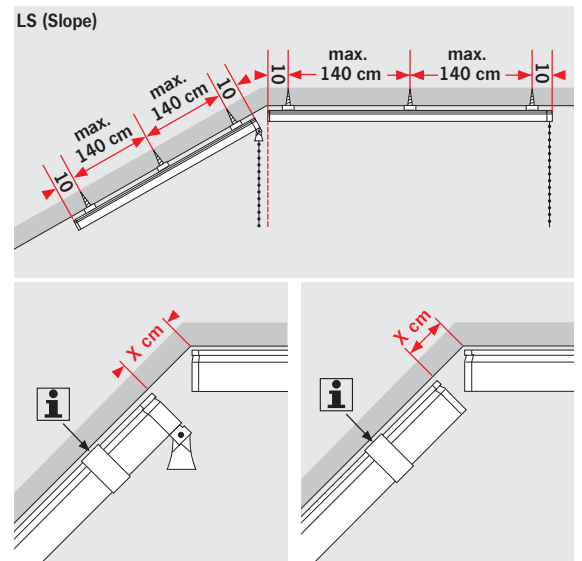
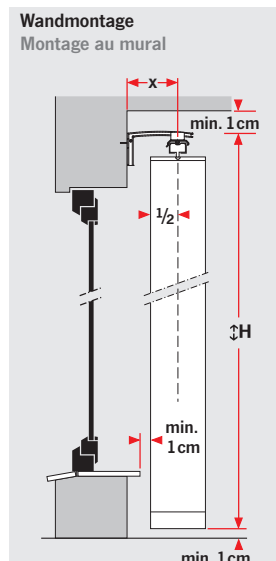
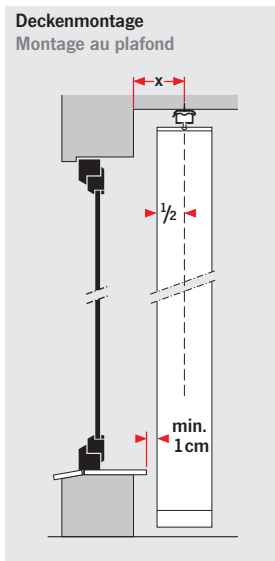
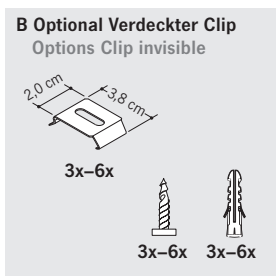
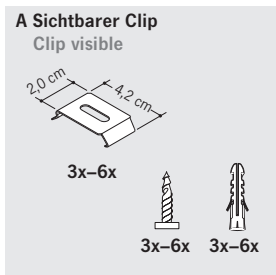

Montagemaß X individuell errechnet – siehe Aufkleber Oberkopf
La cote de pose X est calculée au cas par cas – voir l'étiquette sur la saillie du haut

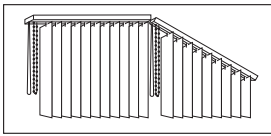

Lamellenvorhang L1/DL1/LS (Slope) Store
à lamelles L1/DL1/LS (inclinaison)

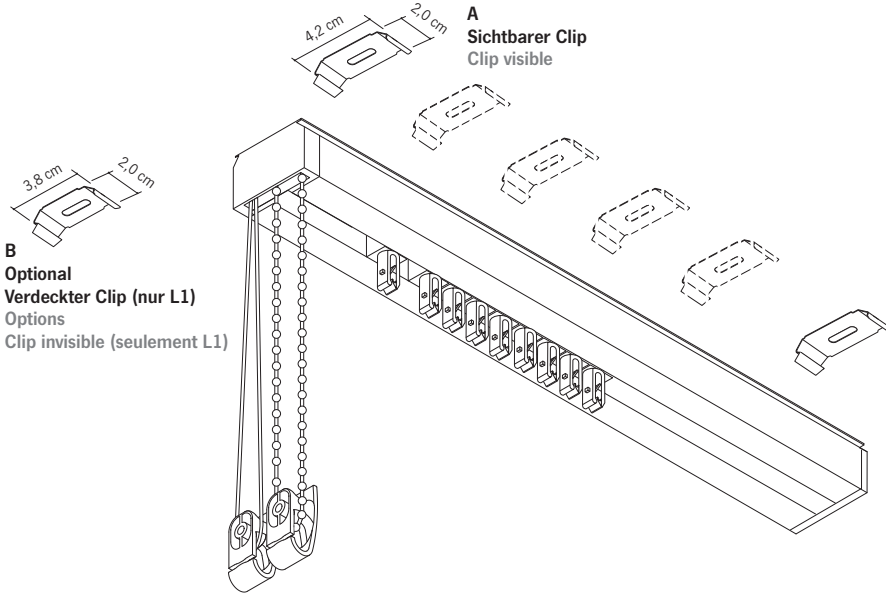

Achtung Attention:

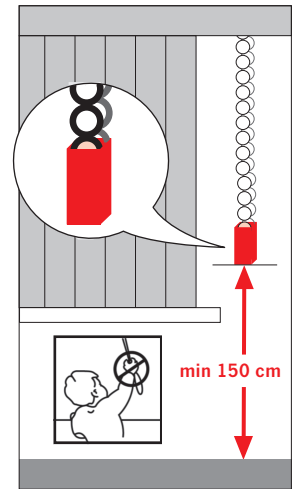

Montagezubehör

Das beiliegende Befestigungsmaterial gilt nur für feste Untergründe. Für die Montage haftet der Montierende.

Accessoires de montage

Le matériel de fixation joint ne peut être appliqué que sur des bases solides. La personne chargée du montage est responsable du montage.

Montagepunkte bestimmen
Déterminer les points de montage

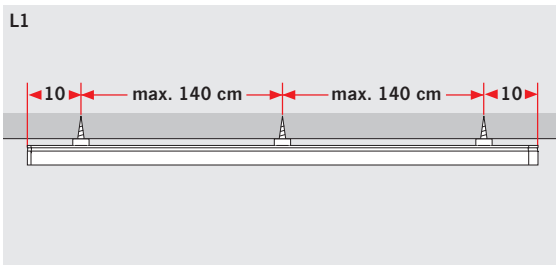
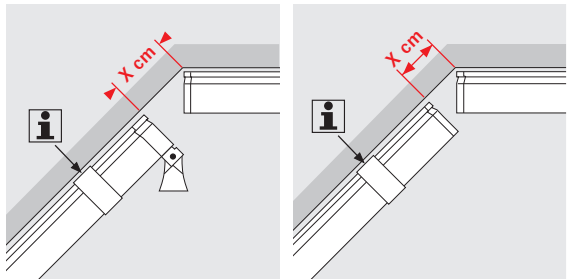
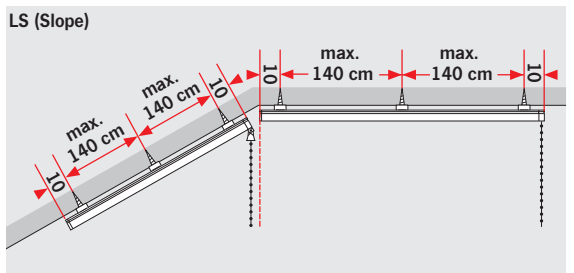
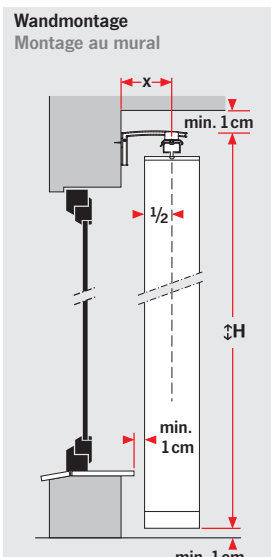
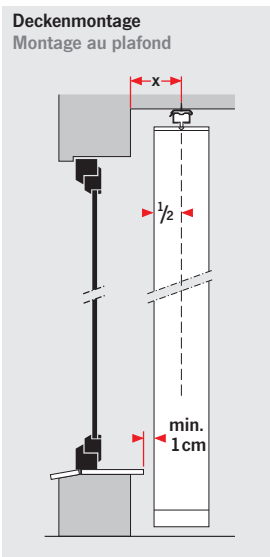
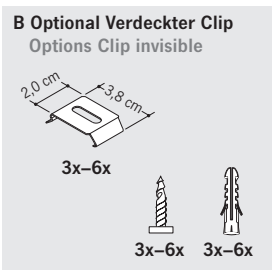
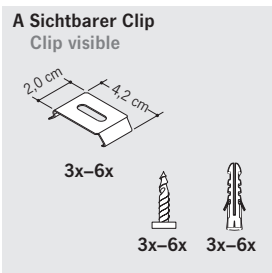

Montagemaß X individuell errechnet – siehe Aufkleber Oberkopf
La cote de pose X est calculée au cas par cas – voir l'étiquette sur la saillie du haut

Montage Montage

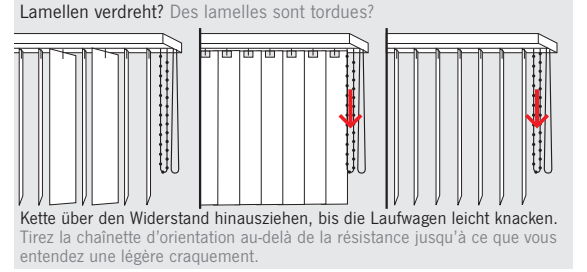
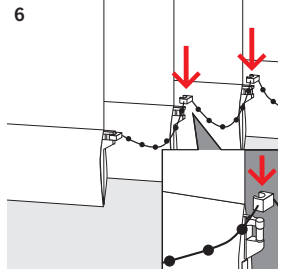
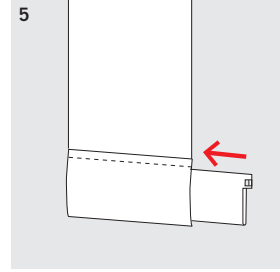
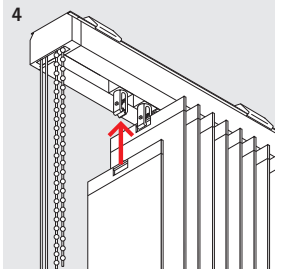
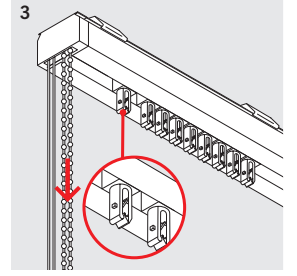
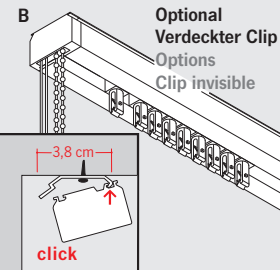
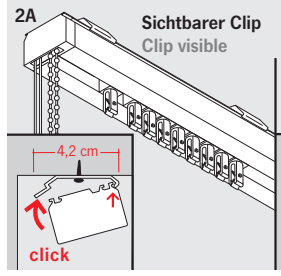
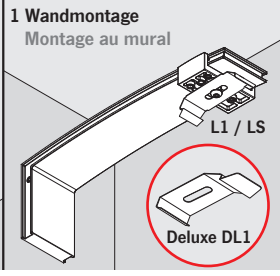
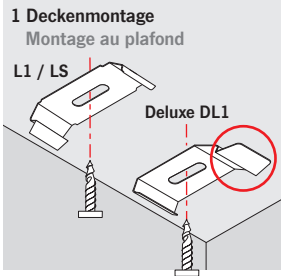

Öffnen und Schließen
Ouvrir et fermer

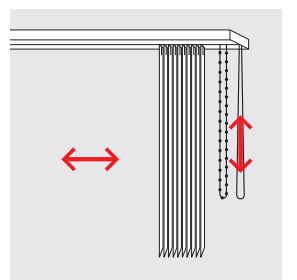
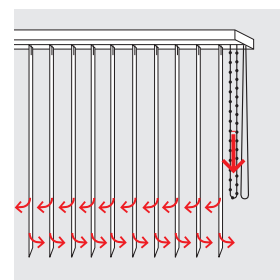
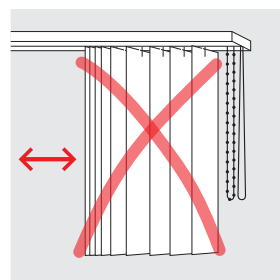

Paket verschieben
Déplacer le paquet

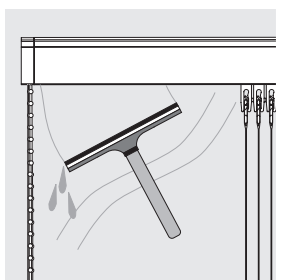
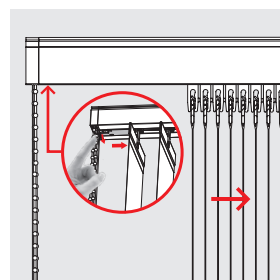

Demontage
Démontage

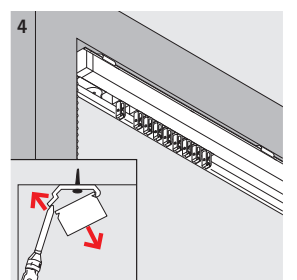
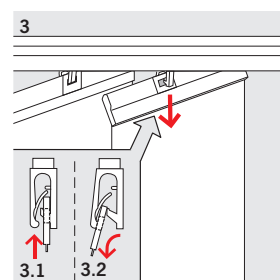
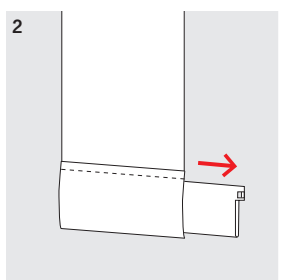
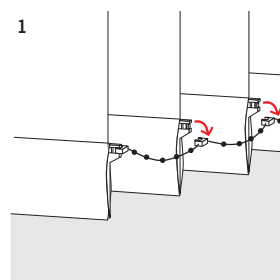

Auswechselbare Haken
(mit Spezialzange)
Achtung!
Schnecke gegen herausfallen
mit Klebeband sichern.
Crochets interchangeables
(avec pince spéciale)
Attention!
Bloquer la roue dentée avec
du ruban adhésif pour éviter
qu'elle ne tombe sur le sol.

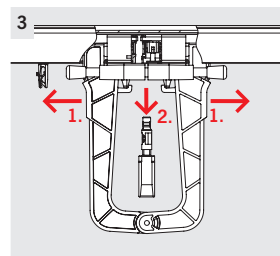
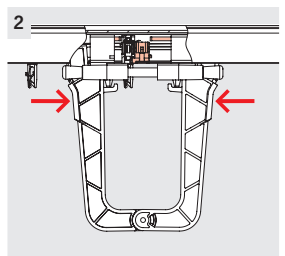
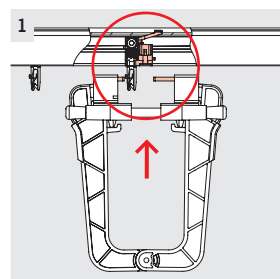

Erkeranlagen Montage:
Installations à encorbellement Montage:

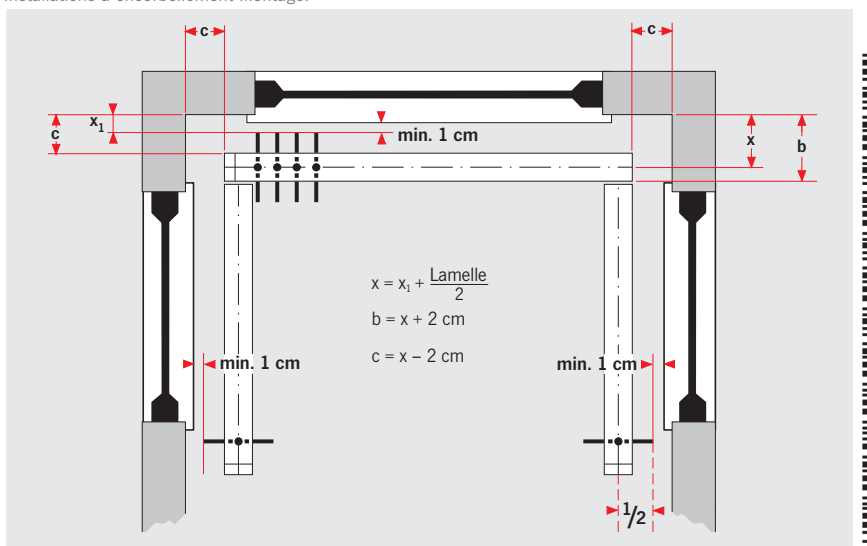

* 05001010101

